

MaxiGrip Standard MX 39 2T/3T

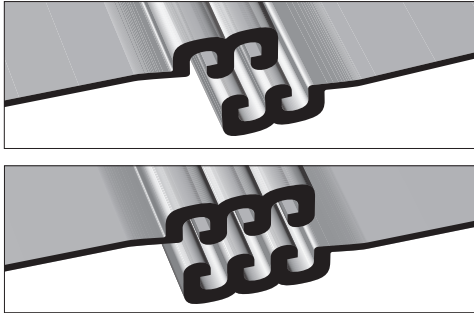

Barrier Closure Protection



MaxiGrip Industrial Zippers & Plastic Closures

Whatever you design or manufacture, MaxiGrip® Plastic Zippers offer a better way to make it open, close, and join together. The MX 39 2-and 3-track is ideal for heavy-to-industrial strength duty flat or horizontal closure applications. It provides a perfect seal with virtually every plastic, woven or non-woven material.

Closures Types

MX392T MaxiGrip 2-Track



2-Track Slider



2-Track Roller

MX393T MaxiGrip 3-Track

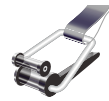

3-Track Roller

Special Order

Custom Sizes

MaxiGrip can design and fabricate custom sizes and configurations to accommodate your special needs.

UV Stabilization

MaxiGrip can stabilize your closures from the harmful effects of Ultra-violet rays.

Custom Colors

MaxiGrip can be manufactured in a variety of colors "to match your product specifications" or to enhance your products visual appeal."

MaxiGrip Applications

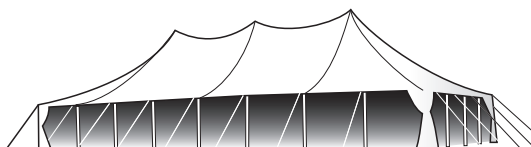

Event
Tents

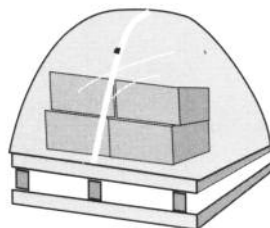

Dry Storage
Covers

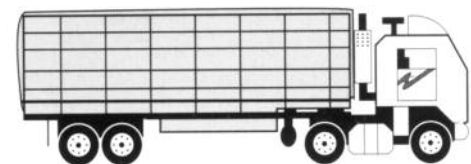

Truck Covers
& Tarpaulins

BARRIER
CLOSURE
PROTECTION



Product Drawings & Specifications

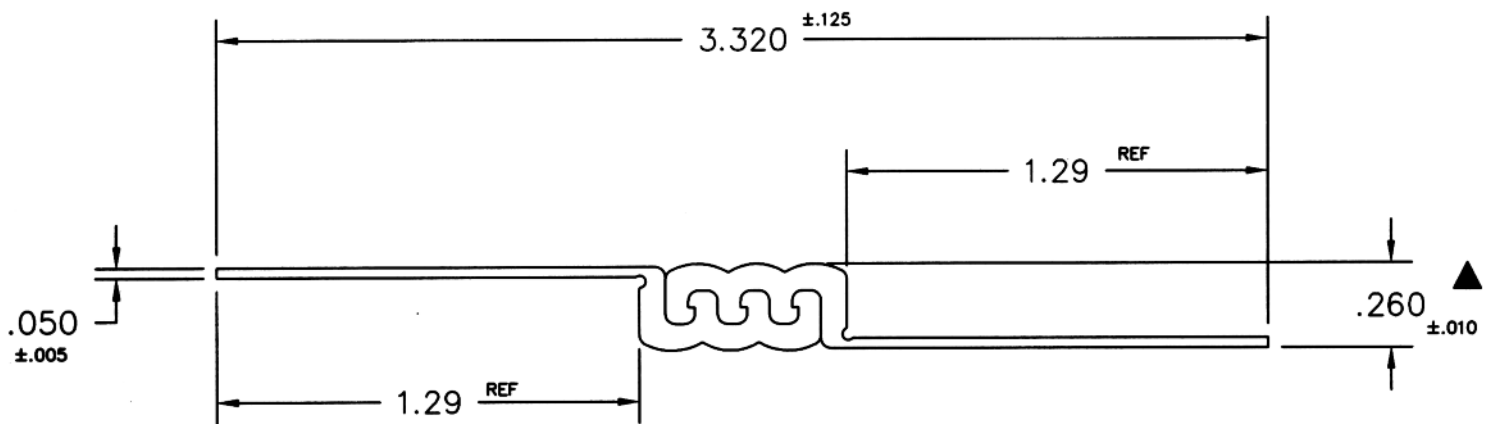
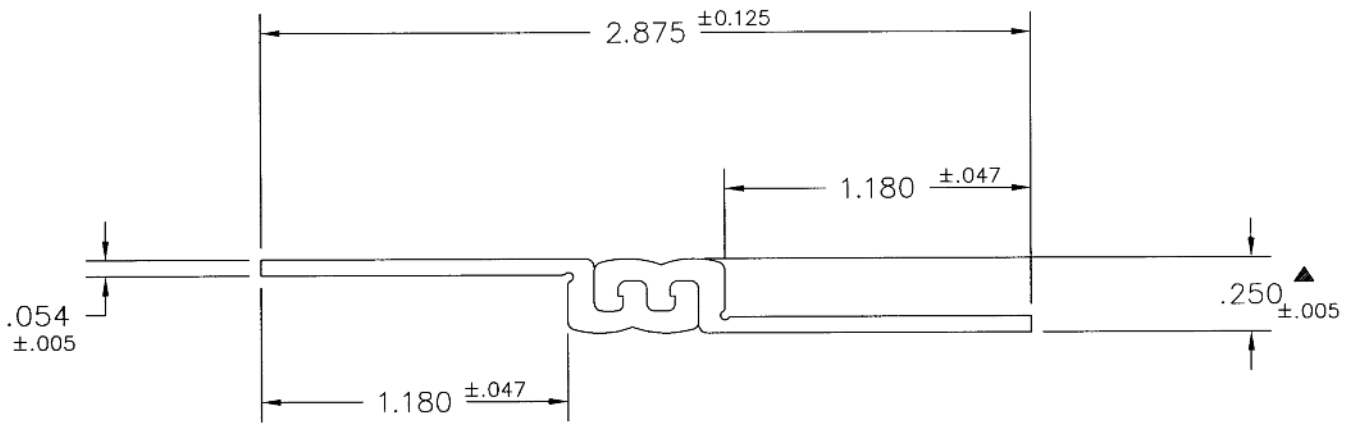

This sketch is for reference only. Dimensions vary according to raw material.

MX 392T/3T pull strength ranges from 20-30 lbs. Values vary between materials, durometer, and fullness of track teeth.

NOTE: Figures based on testing done on an Instron model 3343 based on 1 inch sample at 20 inches of travel per minute with a 100 pound load cell.